

Operating instructions

VEGAPULS WL S 61



Document ID: 54408



VEGA

Operating instructions

Contents

1 About this document	23	7 Set up Bluetooth connection with PC/notebook	31
1.1 Function.....	23	7.1 Preparations.....	31
1.2 Target group	23	7.2 Connecting.....	31
1.3 Symbols used.....	23	7.3 Parameter adjustment	31
2 For your safety.....	23	8 Diagnosis, asset management and service ..	32
2.1 Authorised personnel	23	8.1 Maintenance.....	32
2.2 Appropriate use.....	23	8.2 Measured value and event memory.....	32
2.3 Warning about incorrect use.....	23	8.3 Asset Management function.....	32
2.4 General safety instructions	23	8.4 Rectify faults.....	34
2.5 EU conformity.....	24	8.5 How to proceed if a repair is necessary.....	35
2.6 Radio licenses for Europe.....	24	9 Dismount.....	35
2.7 Radio approval for USA	24	9.1 Dismounting steps.....	35
2.8 Radio approval for Canada.....	25	9.2 Disposal	35
2.9 Installation and operation in the USA and Canada.....	25	10 Supplement.....	36
2.10 Radio license for South Africa	25	10.1 Technical data	36
2.11 Security concept, Bluetooth operation.....	26	10.2 Radio astronomy stations	39
2.12 Environmental instructions	26	10.3 Dimensions	40
3 Product description	26	10.4 Industrial property rights.....	41
3.1 Configuration.....	26	10.5 Hash function acc. to mbed TLS.....	41
3.2 Principle of operation.....	27	10.6 Trademark	41
3.3 Adjustment	27		
3.4 Packaging, transport and storage.....	27		
4 Mounting	28		
4.1 General instructions	28		
4.2 Mounting versions	28		
4.3 Mounting instructions	28		
5 Connecting to power supply	29		
5.1 Preparing the connection.....	29		
5.2 Wiring plan	29		
6 Set up Bluetooth connection with smartphone/ tablet.....	29		
6.1 Preparations.....	29		
6.2 Connecting	30		
6.3 Sensor parameter adjustment	30		

Safety instructions for Ex areas



Take note of the Ex specific safety instructions for Ex applications. These instructions are attached as documents to each instrument with Ex approval and are part of the operating instructions manual.

Editing status: 2018-06-29

1 About this document

1.1 Function

This operating instructions manual provides all the information you need for mounting, connection and setup as well as important instructions for maintenance and fault rectification. Please read this information before putting the instrument into operation and keep this manual accessible in the immediate vicinity of the device.

1.2 Target group

This operating instructions manual is directed to trained personnel. The contents of this manual must be made available to the qualified personnel and implemented.

1.3 Symbols used



Information, tip, note

This symbol indicates helpful additional information.



Caution: If this warning is ignored, faults or malfunctions can result.



Warning: If this warning is ignored, injury to persons and/or serious damage to the instrument can result.



Danger: If this warning is ignored, serious injury to persons and/or destruction of the instrument can result.



Ex applications

This symbol indicates special instructions for Ex applications.

- **List**

The dot set in front indicates a list with no implied sequence.

- **Action**

This arrow indicates a single action.

1 Sequence of actions

Numbers set in front indicate successive steps in a procedure.



Battery disposal

This symbol indicates special information about the disposal of batteries and accumulators.

2 For your safety

2.1 Authorised personnel

All operations described in this documentation must be carried out only by trained specialist personnel authorised by the plant operator.

During work on and with the device the required personal protective equipment must always be worn.

2.2 Appropriate use

VEGAPULS WL S 61 is a sensor for continuous level measurement.

You can find detailed information about the area of application in chapter "*Product description*".

Operational reliability is ensured only if the instrument is properly used according to the specifications in the operating instructions manual as well as possible supplementary instructions.

2.3 Warning about incorrect use

Inappropriate or incorrect use of this product can give rise to application-specific hazards, e.g. vessel overfill through incorrect mounting or adjustment. Damage to property and persons or environmental contamination can result. Also, the protective characteristics of the instrument can be impaired.

2.4 General safety instructions

This is a state-of-the-art instrument complying with all prevailing regulations and directives. The instrument must only be operated in a technically flawless and reliable condition. The operator is responsible for the trouble-free operation of the instrument. When measuring aggressive or corrosive media that can cause a dangerous situation if the instrument malfunctions, the operator has to implement suitable measures to make sure the instrument is functioning properly.

During the entire duration of use, the user is obliged to determine the compliance of the necessary occupational safety measures with the current valid rules and regulations and also take note of new regulations.

The safety instructions in this operating instructions manual, the national installation standards as well as the valid safety regulations and accident prevention rules must be observed

by the user.

For safety and warranty reasons, any invasive work on the device beyond that described in the operating instructions manual may be carried out only by personnel authorised by the manufacturer. Arbitrary conversions or modifications are explicitly forbidden. For safety reasons, only the accessory specified by the manufacturer must be used.

To avoid any danger, the safety approval markings and safety tips on the device must also be observed and their meaning read in this operating instructions manual.

Depending on the instrument version, the emitting frequencies are in the C, K or W band range. The low emission power is far below the internationally approved limit values. When used correctly, the device poses no danger to health.

2.5 EU conformity

The device fulfils the legal requirements of the applicable EU directives. By affixing the CE marking, we confirm the conformity of the instrument with these directives.

You can find the EU conformity declaration on our website under www.vega.com/downloads.

2.6 Radio licenses for Europe

VEGAPULS WL S 61

The instrument was tested according to the latest issue of the following harmonized standards:

- EN 302372 - Tank Level Probing Radar
- EN 302729 - Level Probing Radar

It is hence approved for use inside and outside closed vessels in countries of the EU.

Use is also approved in EFTA countries, provided the respective standards have been implemented.

For operation inside of closed vessels, points a to f in annex E of EN 302372 must be fulfilled.

For operation outside of closed vessels, the following conditions must be fulfilled:

- The installation must be carried out by trained qualified personnel
- The instrument must be stationary mounted and the antenna directed vertically downward

- The mounting location must be at least 4 km away from radio astronomy stations, unless special permission was granted by the responsible national approval authority
- When installed within 4 to 40 km of a radio astronomy station, the instrument must not be mounted higher than 15 m above the ground.

You can find a list of the respective radio astronomy stations in chapter "Supplement".

Bluetooth radio module

The radio module used in the instrument for wireless Bluetooth communication was tested by the manufacturer according to the latest edition of the following standard:

- EN 300328 – Wideband transmission systems

It is hence for use inside closed vessels in countries of the EU and EFTA.

2.7 Radio approval for USA

This approval is only valid for USA. Hence the following text is only available in English language.

This device complies with Part 15 of the FCC Rules.

Operation is subject to the following conditions:

- This device may not cause interference, and
- This device must accept any interference, including interference that may cause undesired operation of the device

This device has been approved for open air environments with the following limitations:

- This device shall be installed and maintained to ensure a vertically downward orientation of the transmit antenna's main beam. Furthermore, the use of any mechanism that does not allow the main beam of the transmitter to be mounted vertically downward is prohibited.
- This device shall be installed only at fixed locations. The LPR device shall not operate while being moved or while inside a moving container.
- Hand-held applications are prohibited.
- Marketing to residential consumers is prohibited.

Changes or modifications not expressly approved by the manufacturer could void the user's authority to operate this equipment.

2.8 Radio approval for Canada

This approval is only valid for Canada. Hence the following texts are only available in English/ French language.

This device complies with Industry Canada's license-exempt RSS standard(s).

Operation is subject to the following conditions:

- This device may not cause interference, and
- This device must accept any interference, including interference that may cause undesired operation of the device

This device has been approved for open air environments with the following limitations:

- This device shall be installed and maintained to ensure a vertically downward orientation of the transmit antenna's main beam. Furthermore, the use of any mechanism that does not allow the main beam of the transmitter to be mounted vertically downward is prohibited.
- The installation of the LPR/TLPR device shall be done by trained installers, in strict compliance with the manufacturer's instructions.
- This device shall be installed only at fixed locations. The LPR device shall not operate while being moved or while inside a moving container.
- Hand-held applications are prohibited.
- Marketing to residential consumers is prohibited.
- The use of this device is on a "no-interference, no-protection" basis. That is, the user shall accept operations of high-powered radar in the same frequency band which may interfere with or damage this device.
- However, devices found to interfere with primary licensing operations will be required to be removed at the user's expense.

Le présent appareil est conforme aux CNR d'Industrie Canada applicables aux appareils radio exempts de licence. L'exploitation est autorisée aux conditions suivantes :

- L'appareil ne doit pas produire de brouillage; et
- L'utilisateur de l'appareil doit accepter tout brouillage radioélectrique subi, même si le brouillage est susceptible d'en compromettre le fonctionnement.

Cet appareil est homologué pour une utilisation dans les environnements ouverts avec les

restrictions suivantes :

- L'appareil doit être installé et entretenu de manière à garantir une orientation verticale vers le bas du faisceau principal de l'antenne émettrice. De plus, l'utilisation de tout mécanisme ne permettant pas l'orientation verticale vers le bas du faisceau principal de l'émetteur est interdite
- L'installation d'un dispositif LPR ou TLPR doit être effectuée par des installateurs qualifiés, en pleine conformité avec les instructions du fabricant.
- Cet appareil ne doit être installé qu'à des emplacements fixes. L'appareil LPR ne doit pas être utilisé pendant qu'il est en train d'être déplacé ou se trouve dans un conteneur en mouvement.
- Les applications portables sont interdites.
- La vente à des particuliers est interdite
- Ce dispositif ne peut être exploité qu'en régime de non-brouillage et de non-protection, c'est-à-dire que l'utilisateur doit accepter que des radars de haute puissance de la même bande de fréquences puissent brouiller ce dispositif ou même l'endommager.
- D'autre part, les capteurs de niveau qui perturbent une exploitation autorisée par licence de fonctionnement principal doivent être enlevés aux frais de leur utilisateur.

2.9 Installation and operation in the USA and Canada

This information is only valid for USA and Canada. Hence the following text is only available in the English language.

Installations in the US shall comply with the relevant requirements of the National Electrical Code (ANSI/NFPA 70).

Installations in Canada shall comply with the relevant requirements of the Canadian Electrical Code

A Class 2 power supply unit has to be used for the installation in the USA and Canada.

2.10 Radio license for South Africa

The instrument was released by the ICASA under the certificate number TA 2017-1763.

2.11 Security concept, Bluetooth operation

Sensor adjustment via Bluetooth is based on a multi-stage security concept.

Authentication

When starting Bluetooth communication, an authentication is carried out between sensor and adjustment device by means of the sensor PIN. The sensor PIN is part of the respective sensor and must be entered in the adjustment device (smartphone/tablet). To increase adjustment convenience, this PIN is stored in the adjustment device. This process is secured via an algorithm acc. to standard SHA 256.

Protection against incorrect entries

In case of multiple incorrect PIN entries in the adjustment device, further entries are possible only after a certain amount of time has passed.

Encrypted Bluetooth communication

The sensor PIN as well as the sensor data are transmitted encrypted between sensor and adjustment device according to Bluetooth standard 4.0.

2.12 Environmental instructions

Protection of the environment is one of our most important duties. That is why we have introduced an environment management system with the goal of continuously improving company environmental protection. The environment management system is certified according to DIN EN ISO 14001.

Please help us fulfil this obligation by observing the environmental instructions in this manual:

- Chapter "Packaging, transport and storage"
- Chapter "Disposal"

3 Product description

3.1 Configuration

Type label

The type label contains the most important data for identification and use of the instrument:



Abb. 17: Layout of the type label (example)

- 1 Instrument type
- 2 Product code
- 3 Field for approvals
- 4 Voltage supply and signal output, electronics
- 5 Protection rating
- 6 Measuring range
- 7 Process and ambient temperature, process pressure
- 8 Material wetted parts
- 9 Serial number of the instrument
- 10 Data matrix code for VEGA Tools app
- 11 Symbol of the device protection class
- 12 Reminder to observe the instrument documentation
- 13 Radio approval for South Africa
- 14 Bluetooth symbol

Sensor PIN

The 4-digit PIN is necessary for the Bluetooth connection to the sensor. The PIN is unique and is only valid of this sensor.

You can find the PIN as a label on the front page of this operating instructions and next to the type label.



Abb. 18: Sensor PIN

Serial number - Instrument search

The type label contains the serial number of the instrument. With it you can find the following instrument data on our homepage:

- Product code (HTML)
- Delivery date (HTML)
- Order-specific instrument features (HTML)
- Operating instructions at the time of shipment (PDF)
- Order-specific sensor data (XML)

Go to "www.vega.com", "Instrument search (serial number)". Enter the serial number.

Alternatively, you can access the data via your

smartphone:

- Download the VEGA Tools app from the "Apple App Store" or the "Google Play Store"
- Scan the Data Matrix code on the type label of the instrument or
- Enter the serial number manually in the app

Scope of this operating instructions manual

This operating instructions manual applies to the following instrument versions:

- Hardware from 1.0.0
- Software from 4.5.2

Scope of delivery

The scope of delivery encompasses:

- Radar sensor with integrated Bluetooth module
- Documentation
 - This operating instructions manual

3.2 Principle of operation

Application area

The radar sensor VEGAPULS WL S 61 is the ideal sensor for typical applications in the water and waste water industry. It is particularly suitable for level measurement in water treatment, in pump stations as well as storm water overflow tanks. The flood-proof IP 68 housing of VEGAPULS WL S 61 ensures a maintenance-free permanent operation. An integrated Bluetooth module enables the wireless communication with smartphone, tablet or PC.

Functional principle

The antenna of the radar sensor emits short radar pulses with a duration of approx. 1 ns. These pulses are reflected by the product and received by the antenna as echoes. The transit time of the radar pulses from emission to reception is proportional to the distance and hence to the level. The determined level is converted into an appropriate output signal and outputted as measured value.

3.3 Adjustment

Wireless adjustment

The adjustment of VEGAPULS WL S 61 is carried out via standard adjustment instruments:

- Smartphone/tablet (iOS or Android operating system)
- PC/notebook with Bluetooth USB adapter (Windows operating system)



Abb. 19: Wireless connection to standard operating devices

- 1 Sensor
- 2 Smartphone/Tablet
- 3 Bluetooth USB adapter
- 4 PC/Notebook

3.4 Packaging, transport and storage

Packaging

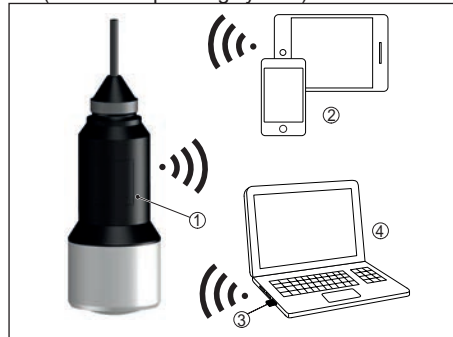
Your instrument was protected by packaging during transport. Its capacity to handle normal loads during transport is assured by a test based on ISO 4180.

The packaging of standard instruments consists of environment-friendly, recyclable cardboard. For special versions, PE foam or PE foil is also used. Dispose of the packaging material via specialised recycling companies.

Transport

Transport must be carried out in due consideration of the notes on the transport packaging. Nonobservance of these instructions can cause damage to the device.

Transport inspection

The delivery must be checked for completeness and possible transit damage immediately at receipt. Ascertained transit damage or concealed defects must be appropriately dealt with.

Storage

Up to the time of installation, the packages

must be left closed and stored according to the orientation and storage markings on the outside.

Unless otherwise indicated, the packages must be stored only under the following conditions:

- Not in the open
- Dry and dust free
- Not exposed to corrosive media
- Protected against solar radiation
- Avoiding mechanical shock and vibration

Storage and transport temperature

- Storage and transport temperature see chapter "*Supplement - Technical data - Ambient conditions*"
- Relative humidity 20 ... 85 %

Lifting and carrying

With instrument weights of more than 18 kg (39.68 lbs) suitable and approved equipment must be used for lifting and carrying.

4 Mounting

4.1 General instructions

Suitability for the process conditions

Make sure before mounting that all parts of the instrument exposed to the process are suitable for the existing process conditions.

These are mainly:

- Active measuring component
- Process fitting
- Process seal

Process conditions in particular are:

- Process pressure
- Process temperature
- Chemical properties of the medium
- Abrasion and mechanical influences

You can find detailed information on the process conditions in chapter "*Technical data*" as well as on the type label.

Suitability for the ambient conditions

The instrument is suitable for standard and extended ambient conditions acc. to IEC/EN 61010-1.

4.2 Mounting versions

Straining clamp

Most simply mount the instrument via the straining clamp. For this purpose, the connec-

tion cable is provided with a strain relief wire of Kevlar.

In order to avoid faulty measured values, make sure that the sensor does not oscillate.



Abb. 20: Mounting via a straining clamp

Mounting bracket

For a rigid mounting, a mounting bracket with opening for thread G1½, e.g. from the VEGA product range, is recommended. The mounting of the sensor in the bracket is carried out via a G1½ counter nut of plastic. Take note of chapter "*Mounting instructions*" for the distance to the wall.

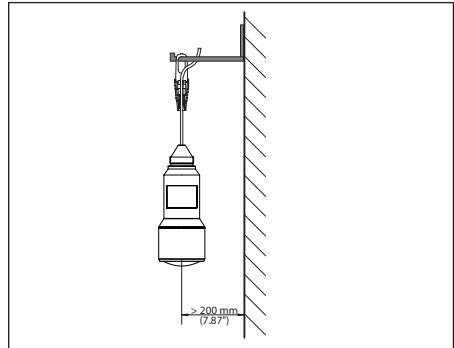

Abb. 21: Mounting via a mounting bracket

4.3 Mounting instructions

Polarisation

The emitted radar impulses of the radar sensor are electromagnetic waves. The polarisation is the direction of the electrical wave component. By turning the instrument in the mounting strap, the polarisation can be used to reduce the effects of false echoes.

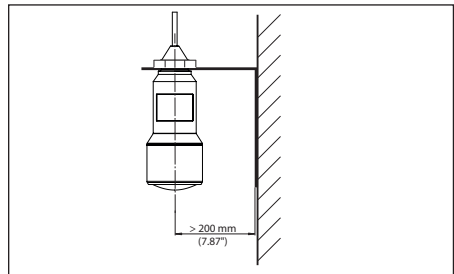
The position of the polarisation is in the middle

of the type label on the instrument.



Abb. 22: Position of the polarisation

1 Middle of the type label

Inflowing medium

Do not mount the instrument in or above the filling stream. Make sure that you detect the product surface, not the inflowing product.

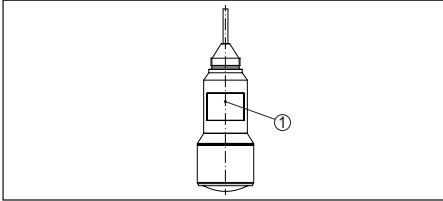

Abb. 23: Mounting of the radar sensor with inflowing medium

5 Connecting to power supply

5.1 Preparing the connection

Safety instructions

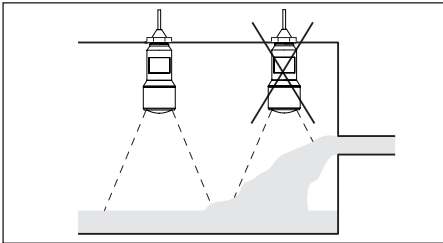
Always keep in mind the following safety instructions:

- Carry out electrical connection by trained personnel authorised by the plant operator
- If overvoltage surges are expected, overvoltage arresters should be installed

Warning:
 Connect only in the complete absence of line voltage.

Voltage supply

Power supply and current signal are carried on the same two-wire cable. The operating voltage can differ depending on the instrument version. The data for power supply are specified in chap-

ter "Technical data".

Provide a reliable separation between the supply circuit and the mains circuits according to DIN EN 61140 VDE 0140-1.

Power the instrument via an energy-limited circuit acc. to IEC 61010-1, e.g. via Class 2 power supply unit.

Keep in mind the following additional factors that influence the operating voltage:

- Lower output voltage of the power supply unit under nominal load (e.g. with a sensor current of 20.5 mA or 22 mA in case of fault)
- Influence of additional instruments in the circuit (see load values in chapter "Technical data")

Connection cable

The instrument is connected with standard two-wire cable without screen. If electromagnetic interference is expected which is above the test values of EN 61326-1 for industrial areas, screened cable should be used.

Make sure that the cable used has the required temperature resistance and fire safety for max. occurring ambient temperature

5.2 Wiring plan

Wire assignment, connection cable



Abb. 24: Wire assignment in permanently connected connection cable

- 1 Brown (+) and blue (-) to power supply or to the processing system
- 2 Shielding

6 Set up Bluetooth connection with smartphone/tablet

6.1 Preparations

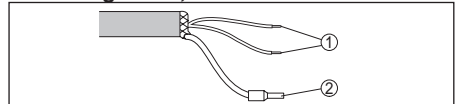
System requirements

Make sure that your smartphone/tablet meets the following system requirements:

- Operating system: iOS 8 or newer
- Operating system: Android 4.3 or newer
- Bluetooth Smart from 4.0

Download the app "VEGA Tools" from the Apple App Store or Google Play Store to your smartphone or tablet.

6.2 Connecting

Connecting ...

Start the "VEGA Tools" app and select the function "Setup". The smartphone/tablet searches automatically for Bluetooth-capable instruments in the area.

The message "*Searching ...*" is displayed.

The found instruments will be listed on the left side of the adjustment window. The search is continued automatically.

Select the requested instrument in the device list.

The message "*Connecting ...*" is displayed.

Authenticate

For the first connection, the operating device and the sensor must authenticate each other. After successful authentication, the next connection functions without authentication.

iOS

During the pairing process, the following message is displayed: "*Pairing request (Bluetooth), e.g. 12345678 wants to pair with your iPad*". Press "Pair".

Android

The coupling passes through automatically.

Enter PIN

For authentication, enter in the next menu window the 4-digit PIN. You can find this PIN on:

- Type label support on sensor cable
- The front page of the operating instructions



Note:

If an incorrect sensor PIN is entered, the PIN can only be entered again after a delay time. This time gets longer after each incorrect entry.

The message "*Waiting for authentication*" is displayed on the smartphone/tablet.

Connected

After connection, the sensor adjustment menu is displayed on the respective adjustment instrument.

If the connection is interrupted, e.g. due to a too large distance between sensor and operating device, this is displayed on the operating device. The message disappears when the connection is restored.

Change sensor PIN

It is recommended to change the default setting of the sensor PIN to your own sensor PIN. To do this, go to the menu item "*Lock adjustment*".

After the sensor PIN has been changed, sensor adjustment can be enabled again. For access (authentication) with Bluetooth, the PIN is still effective.

6.3 Sensor parameter adjustment

Enter parameters

The sensor adjustment menu is divided into two halves:

On the left you'll find the navigation section with the menus "*Setup*", "*Display*", "*Diagnosis*" and others.

The selected menu item, recognisable by the colour change, is displayed in the right half.



Abb. 26: Example of an app view - Setup sensor adjustment

Enter the requested parameters and confirm via the keyboard or the editing field. The settings are then active in the sensor.

Close the app to terminate connection.

7 Set up Bluetooth connection with PC/notebook

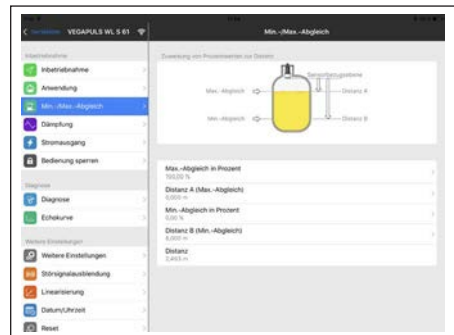
7.1 Preparations

System requirements

Make sure that your PC meets the following system requirements:

- Operating system Windows
- DTM Collection 10/2016 or higher
- USB 2.0 interface
- Bluetooth USB adapter

Activate Bluetooth USB adapter

Activate the Bluetooth USB adapter via the VEGA project assistant (see supplementary instructions "Bluetooth USB adapter"). Sensors with Bluetooth capable PLICSCOM will be found and a project tree created.

7.2 Connecting

Connecting ...

Select the requested sensor for the online parameter adjustment in the project tree.

Authenticate

The window "Authentication" is displayed. For the first connection, the operating device and the sensor must authenticate each other. After successful authentication, the next connection functions without authentication.

Enter PIN

For authentication, enter in the next menu window the 4-digit PIN. You can find this PIN on:

- Type label support on sensor cable
- The front page of the operating instructions



Note:

If an incorrect sensor PIN is entered, the PIN can only be entered again after

a delay time. This time gets longer after each incorrect entry.

Connected

After connection, the sensor DTM appears.

If the connection is interrupted, e.g. due to a too large distance between sensor and operating device, this is displayed on the operating device. The message disappears when the connection is restored.

Change sensor PIN

It is recommended to change the default setting of the sensor PIN to your own sensor PIN. To do this, go to the menu "Additional adjustments", menu item "PIN".

7.3 Parameter adjustment

Prerequisites

For parameter adjustment of the instrument via a Windows PC, the configuration software PACTware and a suitable instrument driver (DTM) according to FDT standard are required. The latest PACTware version as well as all available DTMs are compiled in a DTM Collection. The DTMs can also be integrated into other frame applications according to FDT standard.



Abb. 28: Example of a DTM view - Setup, sensor adjustment

8 Diagnosis, asset management and service

8.1 Maintenance

Maintenance

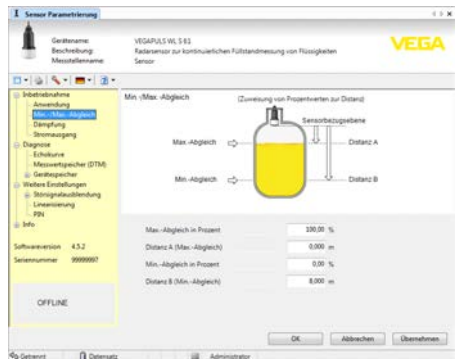
If the device is used properly, no special maintenance is required in normal operation.

Cleaning

The cleaning helps that the type label and markings on the housings, type label and seals.

Take note of the following:

- Use only cleaning agents which do not corrode the housings, type label and seals
- Use only cleaning methods corresponding to the housing protection rating

8.2 Measured value and event memory

The instrument has several memories available for diagnostic purposes. The data remain there even in case of voltage interruption.

Measured value memory

Up to 100,000 measured values can be stored in the sensor in a ring memory. Each entry contains date/time as well as the respective measured value. Storable values are for example:

- Distance
- Filling height
- Percentage value
- Lin. percent
- Scaled
- Current value
- Measurement reliability
- Electronics temperature

When the instrument is shipped, the measured value memory is active and stores distance, measurement reliability and electronics temperature every 3 minutes.

The requested values and recording conditions are set via a PC with PACTware/DTM or the control system with EDD. Data are thus read out and also reset.

Event memory

Up to 500 events are automatically stored with a time stamp in the sensor (non-deletable). Each entry contains date/time, event type, event description and value. Event types are for example:

- Modification of a parameter
 - Switch-on and switch-off times
 - Status messages (according to NE 107)
 - Error messages (according to NE 107)
- The data are read out via a PC with PACTware/DTM or the control system with EDD.

Echo curve memory

The echo curves are stored with date and time and the corresponding echo data. The memory is divided into two sections:

Echo curve of the setup: This is used as reference echo curve for the measurement conditions during setup. Changes in the measurement conditions during operation or buildup on the sensor can thus be recognized. The echo curve of the setup is stored via:

- PC with PACTware/DTM
- Control system with EDD
- Display and adjustment module

Further echo curves: Up to 10 echo curves can be stored in a ring buffer in this memory section. Additional echo curves are stored via:

- PC with PACTware/DTM
- Control system with EDD

8.3 Asset Management function

The instrument features self-monitoring and diagnostics according to NE 107 and VDI/VDE 2650. In addition to the status messages in the following tables there are more detailed error messages available under the menu item "Diagnostics" via app or PACTware/DTM.

Status messages

The status messages are divided into the following categories:

- Failure
 - Function check
 - Out of specification
 - Maintenance requirement
- and explained by pictographs:



Abb. 29: Pictographs of the status messages

- 1 Failure - red
- 2 Out of specification - yellow
- 3 Function check - orange
- 4 Maintenance - blue

Failure: Due to a malfunction in the instrument, a fault message is outputted.

Function check: The instrument is being worked on, the measured value is temporarily invalid (for example during simulation).

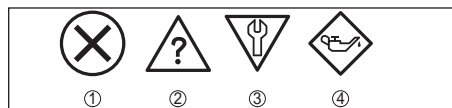
Out of specification: The measured value is unreliable because an instrument specification was exceeded (e.g. electronics temperature).

Maintenance: Due to external influences, the instrument function is limited. The measurement is affected, but the measured value is still valid. Plan in maintenance for the instrument because a failure is expected in the near future (e.g. due to buildup).



Information:

The status messages are always active. It cannot be deactivated by the user.

Failure

Code Text message	Cause	Rectification
F013 no measured value available	<ul style="list-style-type: none"> ● Sensor does not detect an echo during operation ● Antenna system dirty or defective 	<ul style="list-style-type: none"> ● Check or correct installation and/or parameter settings ● Clean or exchange process component or antenna
F017 Adjustment span too small	<ul style="list-style-type: none"> ● Adjustment not within specification 	<ul style="list-style-type: none"> ● Change adjustment according to the limit values (difference between min. and max. ≥ 10 mm)
F025 Error in the linearization table	<ul style="list-style-type: none"> ● Index markers are not continuously rising, for example illogical value pairs 	<ul style="list-style-type: none"> ● Check linearisation table ● Delete table/ Create new
F040 Error in the electronics	<ul style="list-style-type: none"> ● Hardware defect 	<ul style="list-style-type: none"> ● Exchanging the electronics ● Send instrument for repair
F080	<ul style="list-style-type: none"> ● General software error 	<ul style="list-style-type: none"> ● Disconnect operating voltage briefly

Code Text message	Cause	Rectification
F105 Determine measured value	<ul style="list-style-type: none"> ● The instrument is still in the start phase, the measured value could not yet be determined 	<ul style="list-style-type: none"> ● Wait for the end of the switch-on phase ● Duration up to approx. 3 minutes depending on the version and parameter settings
F113 Communication error	<ul style="list-style-type: none"> ● EMC interference 	<ul style="list-style-type: none"> ● Remove EMC influences
F125 Impermissible electronics temperature	<ul style="list-style-type: none"> ● Temperature of the electronics in the non-specified range 	<ul style="list-style-type: none"> ● Check ambient temperature
F260 Error in the calibration	<ul style="list-style-type: none"> ● Error in the calibration carried out in the factory ● Error in the EEPROM 	<ul style="list-style-type: none"> ● Exchanging the electronics ● Send instrument for repair
F261 Error in the configuration	<ul style="list-style-type: none"> ● Error during setup ● False signal suppression faulty ● Error when carrying out a reset 	<ul style="list-style-type: none"> ● Repeat setup ● Repeat reset
F264 Installation/ Setup error	<ul style="list-style-type: none"> ● Adjustment not within the vessel height/measuring range ● Max. measuring range of the instrument not sufficient 	<ul style="list-style-type: none"> ● Check or correct installation and/or parameter settings ● Use an instrument with bigger measuring range
F265 Measurement function disturbed	<ul style="list-style-type: none"> ● Sensor no longer carries out a measurement ● Operating voltage too low 	<ul style="list-style-type: none"> ● Check operating voltage ● Carry out a reset ● Disconnect operating voltage briefly

Tab. 8: Error codes and text messages, information on causes as well as corrective measures

Function check

Code Text message	Cause	Rectification
C700 Simulation active	● A simulation is active	<ul style="list-style-type: none"> ● Finish simulation ● Wait for the automatic end after 60 mins.

Tab. 9: Error codes and text messages, information on causes as well as corrective measures

Out of specification

Code Text message	Cause	Rectification
S600 Impermissible electronics temperature	● Temperature of the electronics in the non-specified range	● Check ambient temperature
S601 Overfilling	● Danger of vessel overfilling	<ul style="list-style-type: none"> ● Make sure that there is no further filling ● Check level in the vessel

Tab. 10: Error codes and text messages, information on causes as well as corrective measures

Maintenance

Code Text message	Cause	Rectification
M500 Error during the reset "delivery status"	● The data could not be restored during the reset to delivery status	<ul style="list-style-type: none"> ● Repeat reset ● Load XML file with sensor data into the sensor
M501 Error in the non-active linearisation table	● Hardware error EEPROM	● Send instrument for repair
M502 Error in the diagnostics memory	● Hardware error EEPROM	● Send instrument for repair

Code Text message	Cause	Rectification
M503 Measurement reliability too low	<ul style="list-style-type: none"> ● The echo/noise ratio is too small for reliable measurement 	<ul style="list-style-type: none"> ● Check installation and process conditions ● Clean the antenna ● Change polarisation direction
M504 Error at a device interface	● Hardware defect	<ul style="list-style-type: none"> ● Check connections ● Send instrument for repair
M505 No echo available	<ul style="list-style-type: none"> ● Level echo can no longer be detected 	<ul style="list-style-type: none"> ● Clean the antenna ● Remove possible false echoes ● Optimize sensor position and orientation

Tab. 11: Error codes and text messages, information on causes as well as corrective measures

8.4 Rectify faults**Reaction when malfunction occurs**

The operator of the system is responsible for taking suitable measures to rectify faults.

Procedure for fault rectification

The first measures are:

- Evaluation of fault messages via the adjustment device
 - Checking the output signal
 - Treatment of measurement errors
- Further comprehensive diagnostics options are available with a PC with PACTware and the suitable DTM. In many cases, the reasons can be determined in this way and faults rectified.

Check the 4 ... 20 mA signal

Connect a multimeter in the suitable measuring range according to the wiring plan. The following table describes possible errors in the current signal and helps to eliminate them:

Error	Cause	Rectification
4 ... 20 mA signal not stable	<ul style="list-style-type: none"> ● Fluctuating measured value 	<ul style="list-style-type: none"> ● Set damping
4 ... 20 mA signal missing	<ul style="list-style-type: none"> ● Electrical connection faulty 	<ul style="list-style-type: none"> ● Check connection, correct, if necessary
	<ul style="list-style-type: none"> ● Voltage supply missing 	<ul style="list-style-type: none"> ● Check cables for breaks; repair if necessary
	<ul style="list-style-type: none"> ● Operating voltage too low, load resistance too high 	<ul style="list-style-type: none"> ● Check, adapt if necessary
Current signal greater than 22 mA, less than 3.6 mA	<ul style="list-style-type: none"> ● Sensor electronics defective 	<ul style="list-style-type: none"> ● Exchange the instrument or send it in for repair

Reaction after fault rectification

Depending on the reason for the fault and the measures taken, the steps described in chapter "Setup" must be carried out again or must be checked for plausibility and completeness.

24 hour service hotline

Should these measures not be successful, please call in urgent cases the VEGA service hotline under the phone no. **+49 1805 858550**.

The hotline is also available outside normal working hours, seven days a week around the clock.

Since we offer this service worldwide, the support is provided in English. The service itself is free of charge, the only costs involved are the normal call charges.

8.5 How to proceed if a repair is necessary

You can find an instrument return form as well as detailed information about the procedure in the download area of our homepage: www.vega.com. By doing this you help us carry out the repair quickly and without having to call back for needed information.

In case of repair, proceed as follows:

- Print and fill out one form per instrument
- Clean the instrument and pack it damage-proof

- Attach the completed form and, if need be, also a safety data sheet outside on the packaging
- Ask the agency serving you to get the address for the return shipment. You can find the agency on our home page www.vega.com.

9 Dismount

9.1 Dismounting steps



Warning:

Before dismounting, be aware of dangerous process conditions such as e.g. pressure in the vessel or pipeline, high temperatures, corrosive or toxic products etc.

Take note of chapters "Mounting" and "Connecting to power supply" and carry out the listed steps in reverse order.

9.2 Disposal

The instrument consists of materials which can be recycled by specialised recycling companies. We use recyclable materials and have designed the electronics to be easily separable.

Correct disposal avoids negative effects on humans and the environment and ensures recycling of useful raw materials.

Materials: see chapter "Technical data"

If you have no way to dispose of the old instrument properly, please contact us concerning return and disposal.

WEEE directive 2012/19/EU

This instrument is not subject to the WEEE directive 2012/19/EU and the respective national laws. Pass the instrument directly on to a specialised recycling company and do not use the municipal collecting points. These may be used only for privately used products according to the WEEE directive.

10 Supplement

10.1 Technical data

General data

Materials, wetted parts

- Antenna PP

Materials, non-wetted parts

- Housing Plastic PBT (Polyester)
- Connection cable PUR
- Type label support on cable PE hard

Thread on the housing

G1½ cylindrical (ISO 228 T1)

Weight

- Instrument 0.7 kg (1.543 lbs)
- Connection cable 0.1 kg/m (0.07 lbs/ft)

Input variable

Measured variable

The measured quantity is the distance between the lower antenna side and the product surface. The reference plane for the measurement is also the lower antenna side.



Abb. 30: Data of the input variable

- 1 Reference plane
- 2 Sensor length
- 3 Max. measuring range

Max. measuring range

8 m (26.25 ft)

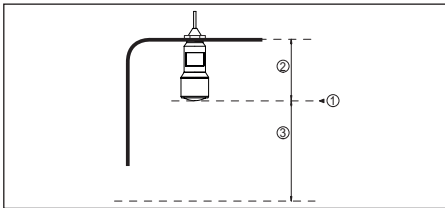
Output variable

Output signal

4 ... 20 mA

Range of the output signal

3.8 ... 20.5 mA (default setting)

Signal resolution

0.3 μ A

Resolution, digital

1 mm (0.039 in)

Fault signal, current output (adjustable)

mA-value unchanged 20.5 mA, 22 mA, < 3.6 mA

Max. output current

22 mA

Load

See load resistance under Power supply

Starting current

\leq 3.6 mA; \leq 10 mA for 5 ms after switching on

Damping (63 % of the input variable), adjustable 0 ... 999 s

Deviation (according to DIN EN 60770-1)

Process reference conditions according to DIN EN 61298-1

- Temperature +18 ... +30 °C (+64 ... +86 °F)
- Relative humidity 45 ... 75 %
- Air pressure 860 ... 1060 mbar/86 ... 106 kPa (12.5 ... 15.4 psig)

Installation reference conditions

- Min. distance to internal installations > 200 mm (7.874 in)
- Reflector Flat plate reflector
- False reflections Biggest false signal, 20 dB smaller than the useful signal

Deviation with liquids ≤ 5 mm (meas. distance > 0.5 m/1.640 ft)

Non-repeatability⁵⁾ ≤ 1 mm

Deviation with bulk solids The values depend to a great extent on the application. Binding specifications are thus not possible.



Abb. 31: Deviation under reference conditions

- 1 Reference plane
- 2 Measuring range

Characteristics and performance data

- Measuring frequency K-band (26 GHz technology)
- Measuring cycle time approx. 450 ms
- Step response time⁶⁾ ≤ 3 s
- Beam angle⁷⁾ 10°
- Emitted HF power⁸⁾
 - Average spectral transmission power density -34 dBm/MHz EIRP
 - Max. spectral transmission power density +6 dBm/50 MHz EIRP
 - Max. power density at a distance of 1 m < 1 μW/cm²

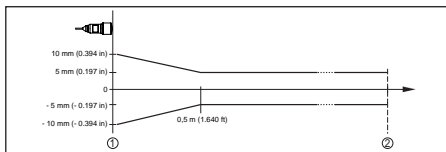
⁵⁾ Already included in the meas. deviation
⁶⁾ Time span after a sudden distance change of max. 0.5 m until the output signal reaches for the first time 90% of the final value (IEC 61298-2).
⁷⁾ Outside the specified beam angle, the energy level of the radar signal is 50% (-3 dB) less.
⁸⁾ EIRP: Equivalent Isotropic Radiated Power

Ambient conditions

Storage and transport temperature	-40 ... +80 °C (-40 ... +176 °F)
-----------------------------------	----------------------------------

Process conditions

For the process conditions, please also note the specifications on the type label. The lower value always applies.

Vessel pressure	-1 ... 2 bar (-100 ... 200 kPa/-14.5 ... 29.0 psig)
-----------------	---

Process temperature	-40 ... +60 °C (-40 ... +140 °F)
---------------------	----------------------------------

Vibration resistance acc. to EN/ IEC 60271-3-4	Class 4M5 (1g) in the range of 5 ... 200 Hz
--	---

Impact resistance acc. to IEC 62262

- ≥ -10 °C (+14 °F)	IK08
--------------------------	------

- < -10 °C ... ≥ -40 °C ($< +14$ °F ... ≥ -40 °F)	IK07
---	------

Electromechanical data - version IP 66/IP 68 (2 bar)

Cable entry	IP 68 cable gland
-------------	-------------------

Connection cable

- | | |
|----------------------------------|--|
| - Configuration | two wires, one Kevlar cable, braiding, cover |
| - Wire cross-section | 0.5 mm ² (AWG 20) |
| - Length | 12 m (39.37 ft) |
| - Min. bending radius | 25 mm (0.984 in) with 25 °C (77 °F) |
| - Diameter approx. | 8 mm (0.315 in) |
| - Wire isolating and cable cover | PUR |
| - Colour | Black |
| - Fire protection classification | UL94-V0 |

Bluetooth interface (optional)

Standard	Bluetooth smart
----------	-----------------

Effective range	25 m (82.02 ft)
-----------------	-----------------

Voltage supply

Operating voltage	9.6 ... 35 V DC
-------------------	-----------------

Reverse voltage protection	Integrated
----------------------------	------------

Permissible residual ripple

- for 12 V $< U_N < 14$ V	$\leq 0.7 V_{\text{eff}}$ (16 ... 400 Hz)
---------------------------	---

- for 18 V $< U_N < 35$ V	$\leq 1.0 V_{\text{eff}}$ (16 ... 400 Hz)
---------------------------	---

Load resistor

- Calculation	$(U_B - U_{\text{min}})/0.022$ A
---------------	----------------------------------

- Example - Non-Ex instrument with $U_B = 24$ V DC	$(24 \text{ V} - 12 \text{ V})/0.022 \text{ A} = 545$ Ω
---	---

Electrical protective measures

Protection rating	IEC 60529 IP 66/IP 68 (2 bar), NEMA Type 6P
-------------------	---

Protection rating (IEC 61010-1)

III

10.2 Radio astronomy stations

Certain requirements for the use outside closed vessels result from the radio license for Europe of VEGAPULS WL S 61. You can find the requirements in chapter "Radio license for Europe". Some of these requirements refer to radio astronomy stations. The following table states the geographic positions of radio astronomy stations in Europe:

Country	Name of the Station	Geographic Latitude	Geographic Longitude
Finland	Metsähovi	60°13'04" N	24°23'37" E
	Tuorla	60°24'56" N	24°26'31" E
France	Plateau de Bure	44°38'01" N	05°54'26" E
	Floirac	44°50'10" N	00°31'37" W
Germany	Effelsberg	50°31'32" N	06°53'00" E
Hungary	Penc	47°47'22" N	19°16'53" E
Italy	Medicina	44°31'14" N	11°38'49" E
	Noto	36°52'34" N	14°59'21" E
	Sardinia	39°29'50" N	09°14'40" E
Poland	Krakow- Fort Skala	50°03'18" N	19°49'36" E
Russia	Dmitrov	56°26'00" N	37°27'00" E
	Kalyazin	57°13'22" N	37°54'01" E
	Pushchino	54°49'00" N	37°40'00" E
	Zelenchukskaya	43°49'53" N	41°35'32" E
Spain	Yebes	40°31'27" N	03°05'22" W
	Robledo	40°25'38" N	04°14'57" W
Switzerland	Bleien	47°20'26" N	08°06'44" E
Sweden	Onsala	57°23'45" N	11°55'35" E
UK	Cambridge	52°09'59" N	00°02'20" E
	Darnhall	53°09'22" N	02°32'03" W
	Jodrell Bank	53°14'10" N	02°18'26" W
	Knockin	52°47'24" N	02°59'45" W
	Pickmere	53°17'18" N	02°26'38" W

10.3 Dimensions

VEGAPULS WL S 61



Abb. 32: Dimensions VEGAPULS WL S 61

10.4 Industrial property rights

VEGA product lines are global protected by industrial property rights. Further information see www.vega.com.

VEGA Produktfamilien sind weltweit geschützt durch gewerbliche Schutzrechte.

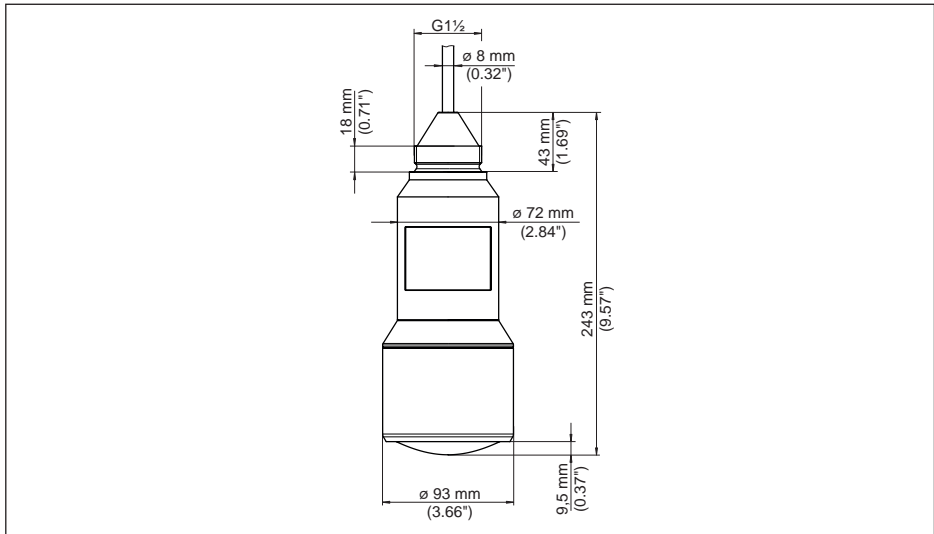
Nähere Informationen unter www.vega.com.

Les lignes de produits VEGA sont globalement protégées par des droits de propriété intellectuelle. Pour plus d'informations, on pourra se référer au site www.vega.com.

VEGA líneas de productos están protegidas por los derechos en el campo de la propiedad industrial. Para mayor información revise la página web www.vega.com.

Линии продукции фирмы ВЕГА защищаются по всему миру правами на интеллектуальную собственность. Дальнейшую информацию смотрите на сайте www.vega.com.

VEGA系列产品在全球享有知识产权保护。

进一步信息请参见网站www.vega.com。

10.5 Hash function acc. to mbed TLS

mbed TLS: Copyright (C) 2006-2015, ARM Limited, All Rights Reserved SPDX-License-Identifier: Apache-2.0

Licensed under the Apache License, Version 2.0 (the "License"); you may not use this file except in compliance with the License. You may obtain a copy of the License at <http://www.apache.org/licenses/LICENSE-2.0>.

Unless required by applicable law or agreed to in writing, software distributed under the License is distributed on an "AS IS" BASIS, WITHOUT WARRANTIES OR CONDITIONS OF ANY KIND, either express or implied. See the License for the specific language governing permissions and limitations under the License.

10.6 Trademark

All the brands as well as trade and company names used are property of their lawful proprietor/originator.

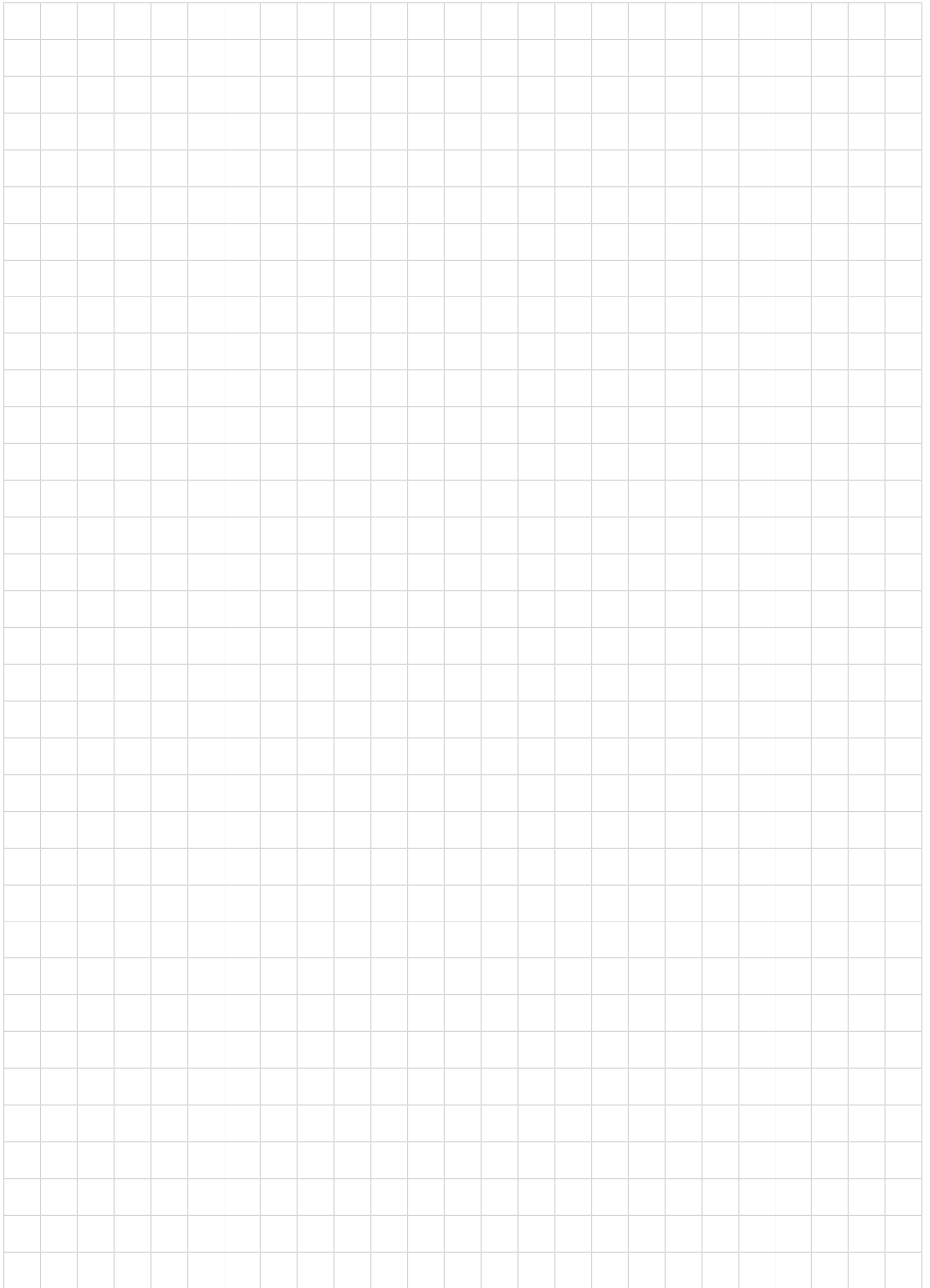

54408-01-180705



54408-01-180705

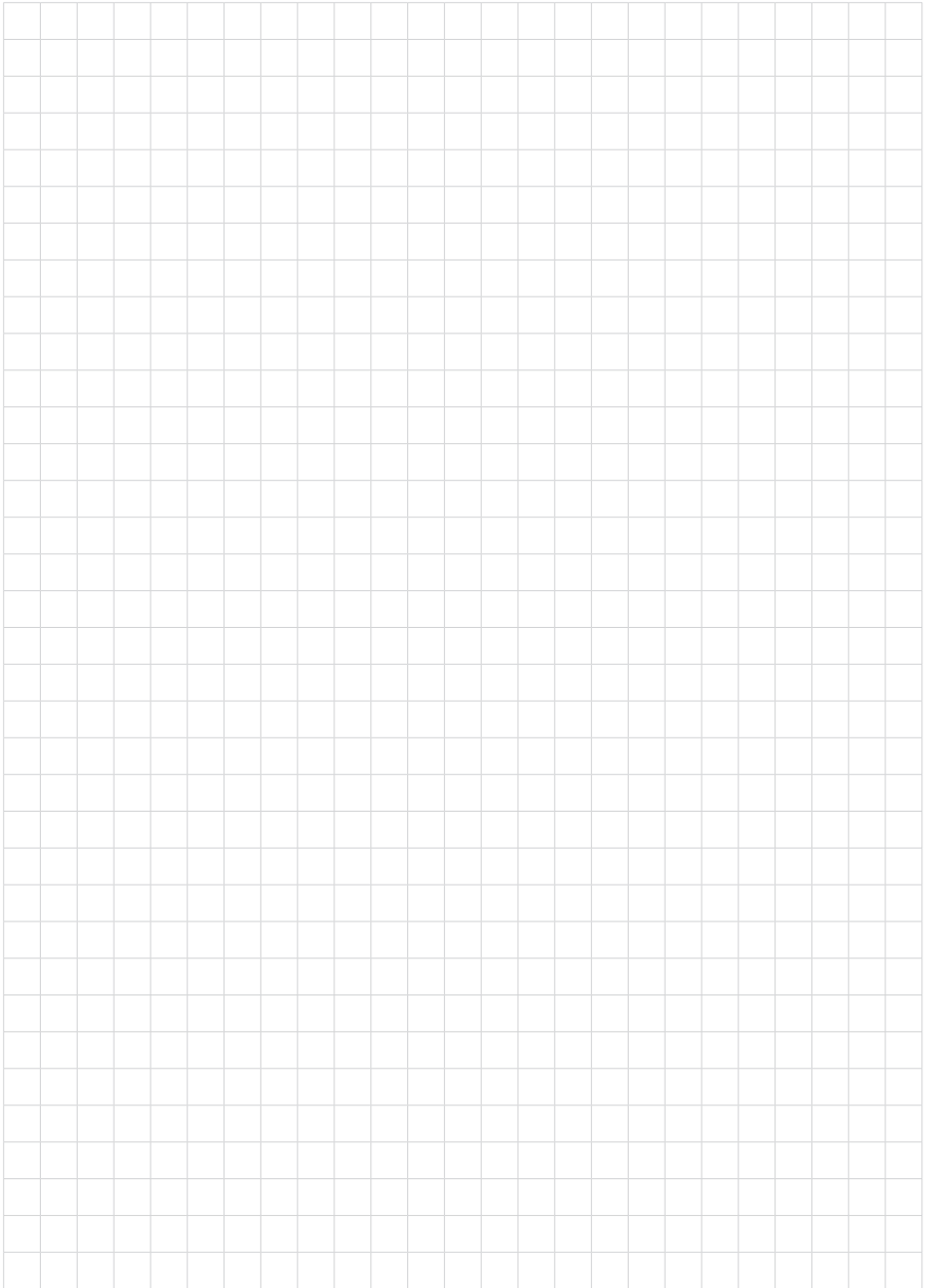

54408-01-180705

Printing date:

VEGA

Die Angaben über Lieferumfang, Anwendung, Einsatz und Betriebsbedingungen der Sensoren und Auswertsysteme entsprechen den zum Zeitpunkt der Drucklegung vorhandenen Kenntnissen.

All statements concerning scope of delivery, application, practical use and operating conditions of the sensors and processing systems correspond to the information available at the time of printing.

Les indications de ce manuel concernant la livraison, l'application et les conditions de service des capteurs et systèmes d'exploitation répondent aux connaissances existantes au moment de l'impression.

Las informaciones acerca del alcance de suministros, aplicación, uso y condiciones de funcionamiento de los sensores y los sistemas de análisis corresponden con los conocimientos existentes al momento de la impresión.

Änderungen vorbehalten Subject to change without prior notice Sous réserve de modifications Reservado el derecho de modificación

© VEGA Grieshaber KG, Schiltach/Germany 2018



54408-01-180705

VEGA Grieshaber KG
Am Hohenstein 113
77761 Schiltach
Germany

Phone +49 7836 50-0
Fax +49 7836 50-201
E-mail: info.de@vega.com
www.vega.com